

# The Larsen 'Kit of Parts'

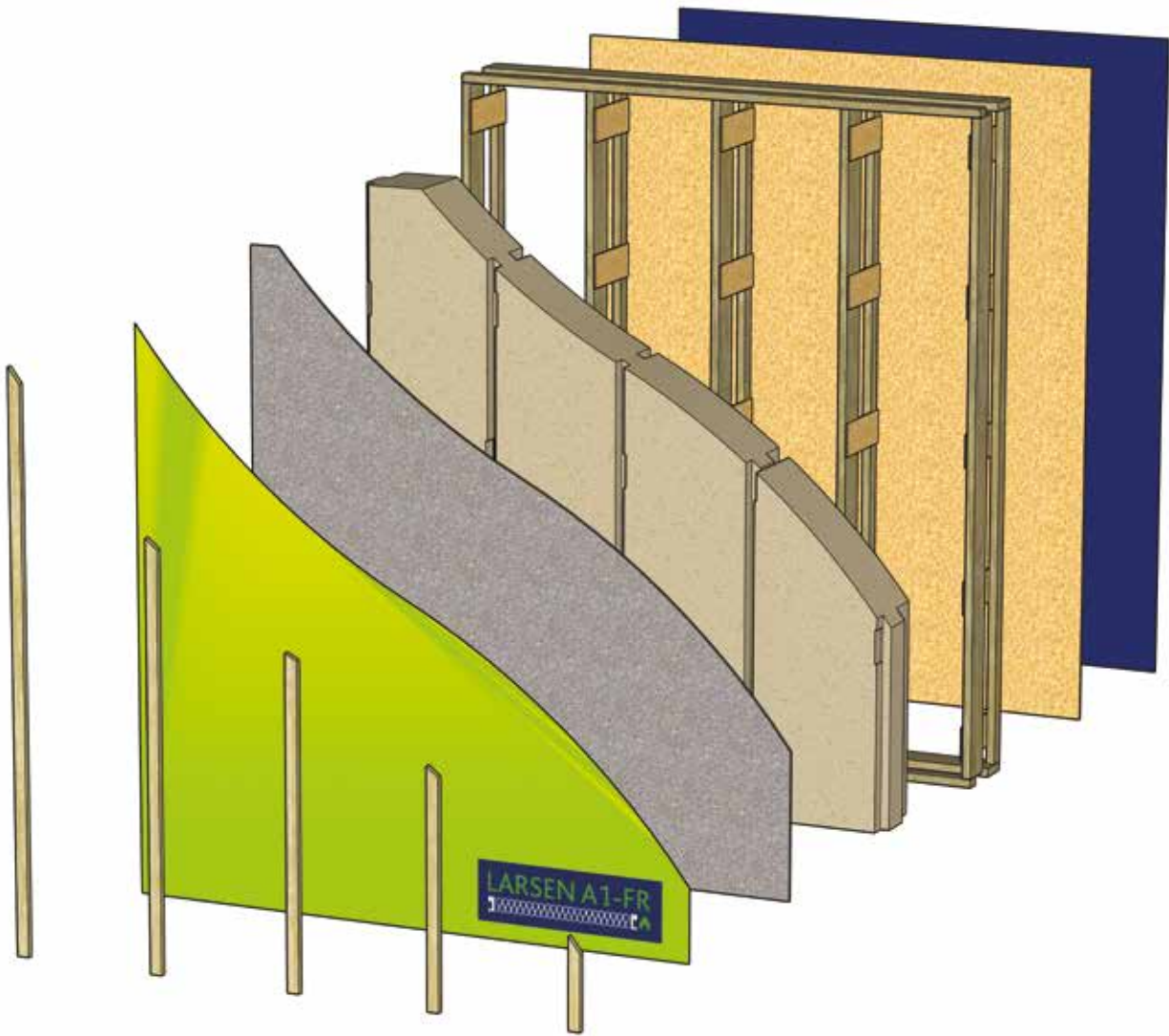

Our Innovative systemised approach for low energy buildings



[timberinnovations.co.uk](https://timberinnovations.co.uk)  
[timberframe.co.uk](https://timberframe.co.uk)

## About us

Our Larsen System has been developed to address the current and future demands for low energy buildings – offering a tested, systemised ‘kit of parts’ to enable architects, developers and contractors to simply create complete insulated superstructures. Back in 1981 John Larsen, a builder in Edmonton, Alberta invented the concept of a twin stud design, providing all the necessary structural performance but importantly with significantly reduced cold-bridging. We’ve developed and tested this concept into a complete Modern Method of Construction (MMC) wall, floor and roof ‘Kit of Parts’.

The closed panel format is flexible for a range of insulation types and overall U-value performance right down to Passivhaus requirements. Furthermore the wall system has been fire tested and achieved 100 minute performance in a load bearing test, utilising blown A1 fire rated insulant enabling use on many commercial and education schemes.

Design, Engineer, Manufacture  
and Installation

Part of the Wyckham Blackwell  
Group of companies



[timberframe.co.uk](http://timberframe.co.uk)



Our network of manufacturing facilities across the UK ensures we are always ‘local’ to the site, allowing us to provide the best service and optimise deliveries to significantly reduce transport miles. Our experienced team of in-house engineers, designers and project

managers will assist you at every stage of the project from initial advice through to final inspection and handover. We pride ourselves on offering market leading timber engineering products and ensuring health & safety is at the core of everything we do.

## Contents

<b>The Larsen System</b>	<b>4</b>	<b>Roofs</b>	<b>13</b>
<b>Fire Tested Solution</b>	<b>5</b>	<b>Wrap – Infill Solutions</b>	<b>14</b>
<b>Natural Insulation Options</b>	<b>6</b>	<b>Department For Education</b>	<b>15</b>
<b>Passivhaus Performance</b>	<b>7</b>	Framework Requirements	
<b>Airtightness</b>	<b>8</b>	<b>BIM &amp; Technical</b>	<b>16</b>
<b>U-values/Psi-values</b>	<b>9</b>	<b>Installation</b>	<b>17</b>
<b>Internal Wall Systems</b>	<b>10</b>	<b>Sustainability</b>	<b>18-19</b>
<b>Floor Cassettes</b>	<b>11</b>		
<b>Concrete Floors</b>	<b>12</b>		

# The Larsen System

Timber Innovations have extensive experience of low energy buildings and Passivhaus developments. We've applied our comprehensive knowledge to develop a systemised approach to enable an 'off the shelf' kit of parts as an offsite solution. This allows architects, specifiers and developers to use a system that has a track record of achieving the stringent thermal and airtightness requirements necessary for such buildings. Our team can help you integrate proven detailing whether you are building a large commercial scheme or your very own self-build project.

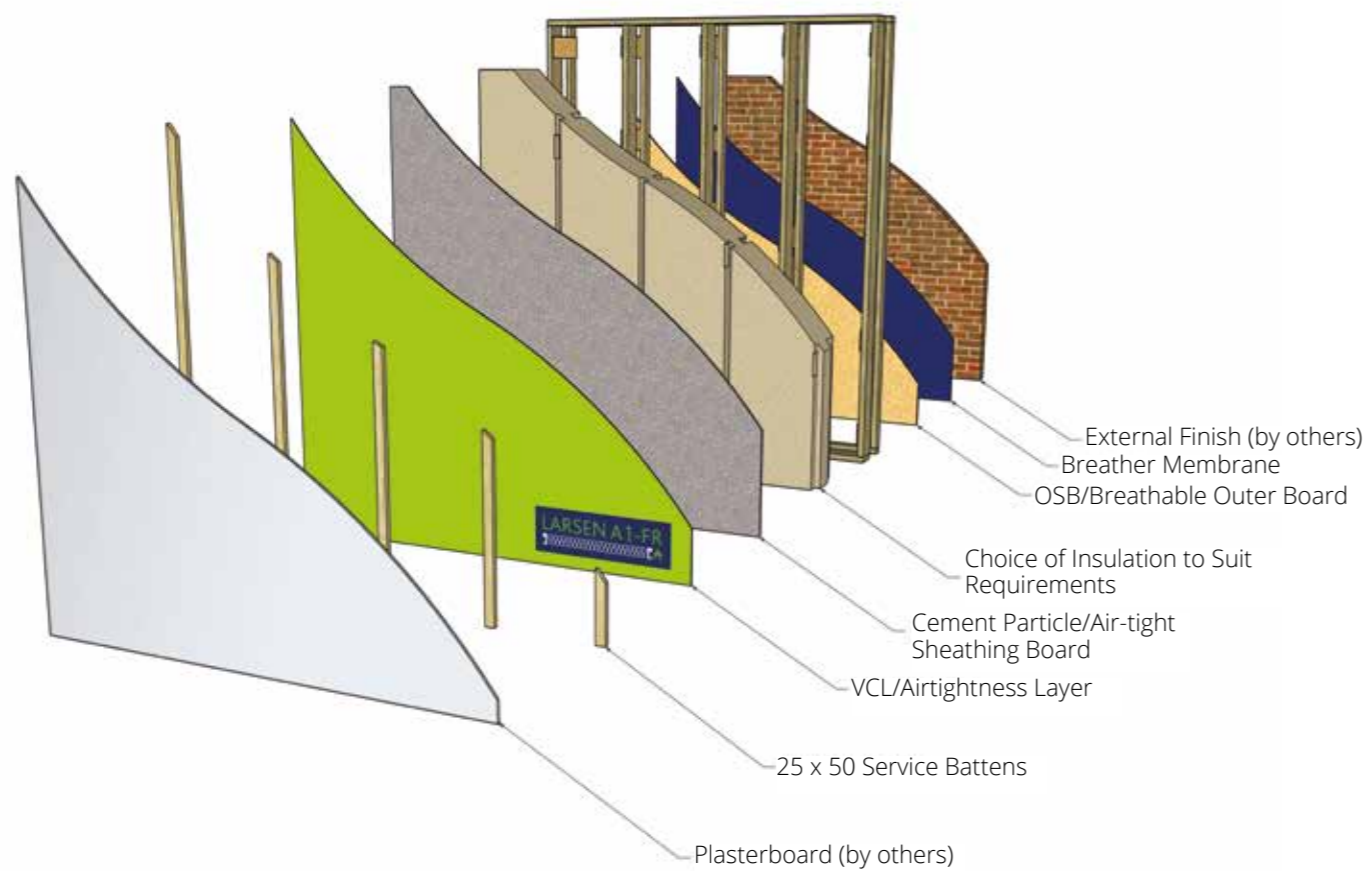

# Fire Tested Solution

We have fire tested our Larsen wall make-up and achieved a load-bearing test result of 100 minutes. This test data has been commissioned to provide confidence when specifying the Larsen System and is available to our partners to integrate into the overall fire strategy for the project. Furthermore we have extensive fire tested solutions for walls, floors and roofs available to us through our partners and can tailor these specifically once we understand your project requirements, please talk to our technical team.

- Tested in accordance with BS EN 1363-1:2020 and BS EN 1365-1:2012
- Fire Test Report – EUI-22-B-00315 – Load Bearing Test
- 100 minute performance
- A1 Insulation fill – Range of U-values to Passiv levels

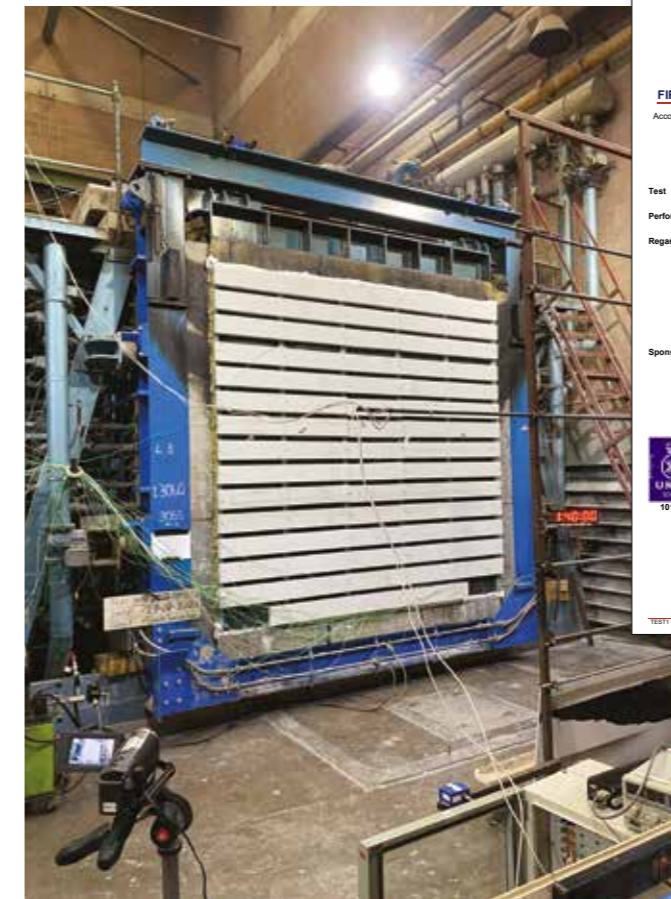

Efectis UK/Ireland Ltd Efectis UK/Ireland		TEST REPORT
<b>FIRE TEST REPORT EUI-22-B-00315</b>		
According to BS EN 1363-1:2020 and BS EN 1365-1:2012		
Test	EUI-22-B-00315	
Performed on	25 <sup>th</sup> of August, 2022	
Regarding	Larsen Fire Test Panel Overall dimensions: 3000 x 2950 x 306 mm (w x h x t) Fire side: One layer of type 12.5 mm plasterboard, reference Knauf Fire Panel (Knauf) fixed to the Service Battens secured to Internal layer, reference RCM Multipurpose (RCM), 12 mm thick Non-fire side: External battens, reference 25 x 50 External Battens (Sodra) and Breather membrane, reference Nova Black 115 GSM Roof and Wall Breather secured to the External board, reference Medite Vent (Smarqvy) Loading: 55 kN	
Sponsor	WB TIMBER INNOVATIONS LTD (Part of the Wyckham Blackwell group of companies) Highlands Road B90 4NZ Shirley UNITED KINGDOM	
		
<small>10169</small>		
<small>10169</small>		

**KNAUF**INSULATION

## Natural Insulation Options

Today's market demands focus on the source, sustainability and carbon efficiency of all insulation materials from 'cradle to grave' and we've seen a step change in understanding of the benefits from using natural materials. Our Larsen system can accommodate almost any insulation material and is adaptable to suit its thermal performance and target U-value by simply adjusting the panel depth to suit – even allowing for varying cladding types across the project. The closed panel format ensures insulation can be factory blown into the panel at the desired density and our ISO quality checks offer confidence for the overall performance of the building envelope.

### Cellulose – Blown

- Manufactured from recycled newspaper
- High density fill helps stabilise temperatures
- Water vapour open for a healthy internal climate



### Sheep's Wool

- Abundant natural by-product
- Biodegradable and compostable
- Hygroscopic fibre

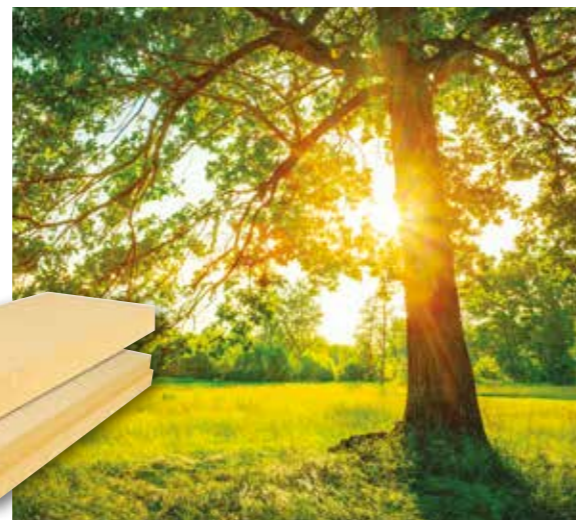

### Wood Fibre

- Made from natural wood fibres
- Diffusion open - Breathable
- Helps to regulate the indoor climate



For more information on any of our products visit [timberinnovations.co.uk](https://www.timberinnovations.co.uk)

## Passivhaus Performance

Passivhaus has fast become the leading brand for low energy buildings and we understand from extensive experience what is needed (and to be avoided!) in the delivery of this quality of build. The low thermal and air permeability requirements must be integrated right from the initial designs and continue through every build stage to project completion. In our experience the Passivhaus discipline is an effective measure to achieving low/net zero energy buildings that offer exceptional thermal comfort and ultimately lower running costs for the life of the building.



- U-value performance to 0.09 U-value
- Airtightness – proven to achieve less than 1m<sup>3</sup>/h/m<sup>2</sup>@50pa
- Enhanced Psi-values to complement architectural detailing
- Natural or A1-FR insulation options

The Passivhaus 'Museum of Speed' in Pendine, Wales



For more information on any of our products visit [timberinnovations.co.uk](https://www.timberinnovations.co.uk)

# Airtightness

Factory-produced solutions allow optimum detailing at all interfaces for achieving airtightness performance. Attention to detail at every site interface within our superstructure allows easy integration with follow-on trades, whilst ensuring the building envelope can perform even down to Passiv levels. As thermal performance and Airtightness are interlinked the benefits of our Larsen panels need to be incorporated into an overall project strategy and we will work alongside the wider design team to ensure a successful result.

We encourage early design-stage engagement to ensure simple and effective junction detailing.

We offer a range of airtightness membranes, tapes and boards with proven detailing to achieve Passivhaus, BREEAM and LEEDS performance levels



## Airtightness red line agreed at early design stage

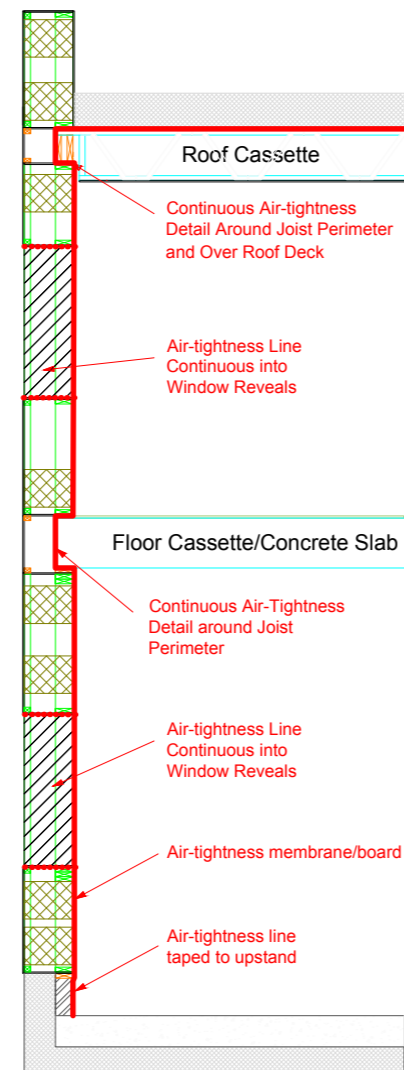

# U-values/Psi-values

The measurements of heat loss from a building have an obvious direct link to energy efficiency. Our Larsen system is designed to allow maximum fill with almost any insulation material and minimise thermal bridging at its junctions. U-values right down to less than 0.1W/m<sup>2</sup>K are readily available where required.

Psi-values are a calculated assessment of the actual level of thermal bridging especially at junction conditions so we are able to prove the excellent performance of the building.

## U-values

### Typical U-values

Insulation Zone	Ventilated Cladding	Masonry Outer Skin
223mm	0.17 W/m <sup>2</sup> K	0.15 W/m <sup>2</sup> K
243mm	0.15 W/m <sup>2</sup> K	0.13 W/m <sup>2</sup> K
362mm	0.10 W/m <sup>2</sup> K	0.09 W/m <sup>2</sup> K
388mm	0.09 W/m <sup>2</sup> K	0.08 W/m <sup>2</sup> K

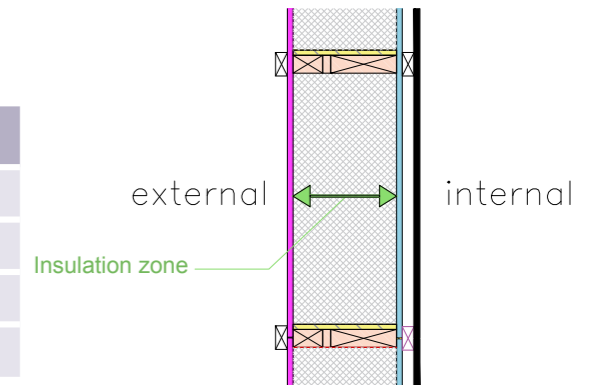

## E5 condition

### Temperature Distribution Diagram

Psi-Value (W/m-k)=0.039  
Temperature Factor (f) = 0.93

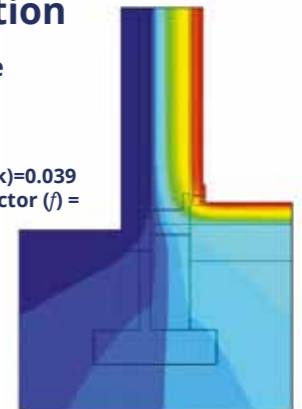

## Psi-values

### Typical Psi-values











Ref	Psi Junction Refs	Psi-value (W/m.K)	Notes
E4	Window Jamb	0.036	
E5	Ground Floor (normal)	0.039	Based on Passiv slab
E6	Intermediate Floor	0.095	Concrete intermediate planks assumed 200mm deep
E6	Intermediate Floor	0.052	Timber metal web beams with insulated rimbeam
E15	Flat roof with Parapet	0.097	Assumes 130mm insulation over
E16	Panel Corner (normal)	0.05	

We can provide project specific U-value and Psi-value calculations. **Talk to our technical team.**

# Internal Wall Systems

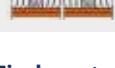



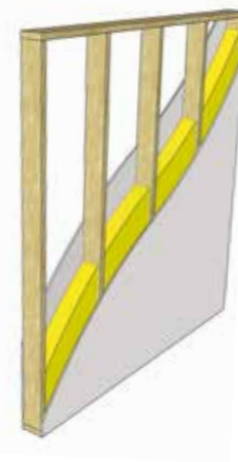

We offer a range of internal wall systems, from conventional “skeleton” stud panels – either as loadbearing walls or partitions (non-loadbearing) – right through to closed panels complete with insulation and sheathing to both faces. These can be tailored to meet your project requirements for acoustics, fire and structural robustness and have comprehensive test data to back up their performance.

## Timber stud walls - non-load bearing

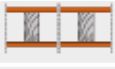
System Drawing	Wall Thickness (mm)	Boarding per side (mm)	Mineral Wool Thickness/Density (mm)/(Kg/m <sup>3</sup> )	Airborne Sound Insulation Index R <sub>w</sub> (dB)	Flanking Sound Insulation D <sub>nf,w</sub> (dB)	Fire Protection (Minutes) EN BS
	114	12.5	none	41	55	E130 -
	100	15	none	41	55	- F60
	213	12.5	none	49	55	E130 -
	275	12.5	none	49	55	E130 -
	≥139	2 x 12.5	90/10	51	63	E160 -
	114	12.5	70/35	44	59	E160 -
	≥213	12.5	70/35 Twin layer insulation may be used	57	63	E160 -
	≥175	12.5	70/35 Twin layer insulation may be used	57	63	E160 -
	≥200	12.5 + 10 or 2 x 12.5	90/10	64	63	E160 -
	≥238	2 x 12.5	90/10	64	63	E160 -
	127	12.5 + 2 x 12.5	70/35	49	59	E160 -



## Timber stud walls - load bearing

System Drawing	Wall Thickness (mm)	Boarding per side (mm)	Mineral wool Thickness/Density (mm)/(Kg/m <sup>3</sup> )	Partition Load	Airborne Sound Insulation Index R <sub>w</sub> (dB)	Flanking Sound Insulation D <sub>nf,w</sub> (dB)	Fire protection (Minutes) EN BS	Board Fixing Method
	114	12.5	none	5.56kN/Stud	41	55	REI30 -	staple
	170	15	140/30	10.75 kN/stud	≥46	59	REI60 -	staple
	150	15	120/30	10.8kN/stud	≥46	59	REI60 -	staple
	127	2 x 12.5mm (REI 60 fire side) & 12.5mm (REI30 fire side)	90/10	5.56kN/Stud	≥46	≥59	REI60-30 - 60 mins from double layer side, 30 mins from single layer side)	staple/nail
	≥258	2 x 12.5mm Inner cavity single layer may be timber based product	90/10	5.56kN/Stud	≥66	63	REI60 -	staple/nail
	139	2 x 12.5mm	90/10	5.56kN/Stud	≥51	≥59	REI60 -	staple/nail

Test Data extract from Orange Book **fermacell**

# Floor Cassettes

We offer a range of engineered timber floor cassettes – using I-beams, metal-web joists or CLT planks – plus a variety of structural floor boarding over. Cassette floors accelerate the installation process and ensure factory quality control is extended into the site environment.

## Joist Guidance

### I-Joist Range

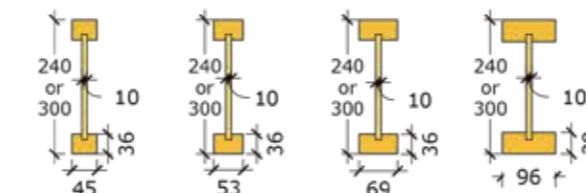

Span up to:  
**5.6m    5.7m    6.15m    6.7m**

Some I-Joists available up to 400m deep

- Timber based solution – Optimum carbon footprint
- Lightweight construction
- Flexible for service runs and MVHR
- Engineered for stability and robustness
- Options for screed and acoustic overlays – talk to our team



## Metal-Web Joist Range

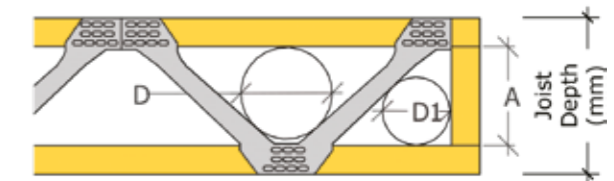

Joist Size	219	254	304	417
A (mm)	125	160	125	323
D (mm)	100	150	100	280
D1 (mm)	100	100	100	190
Span up to	6.07m	6.63m	7.38m	8.28m

Subject to load criteria

- Guidance only: Contact our office for full joist details & capacity
- Choice of end conditions & joist spacing

For more information on any of our products visit [timberinnovations.co.uk](http://timberinnovations.co.uk)

## Concrete Floors

As an alternative to our range of engineered timber floor cassettes we can incorporate precast concrete plank floors which suit long-span requirements under high loads, such as classrooms and office spaces. By using hollow-core concrete planks their thermal-mass effect moderates temperatures within the building, providing benefits with heating/cooling considerations – as well as controlling acoustic separation between rooms above and below. Our experience allows careful detailing of support elements, with timber structural walls and steels as appropriate, and structural grouting ensures the planks integrate fully with other parts of our timberframe structure.

- Designed to BS EN 1992-1-1 and BS EN 1992-1-2
- Long spans / High load capacity
- Immediate working platform
- Preformed holes for services
- Fire resistance rating of up to 2 hours

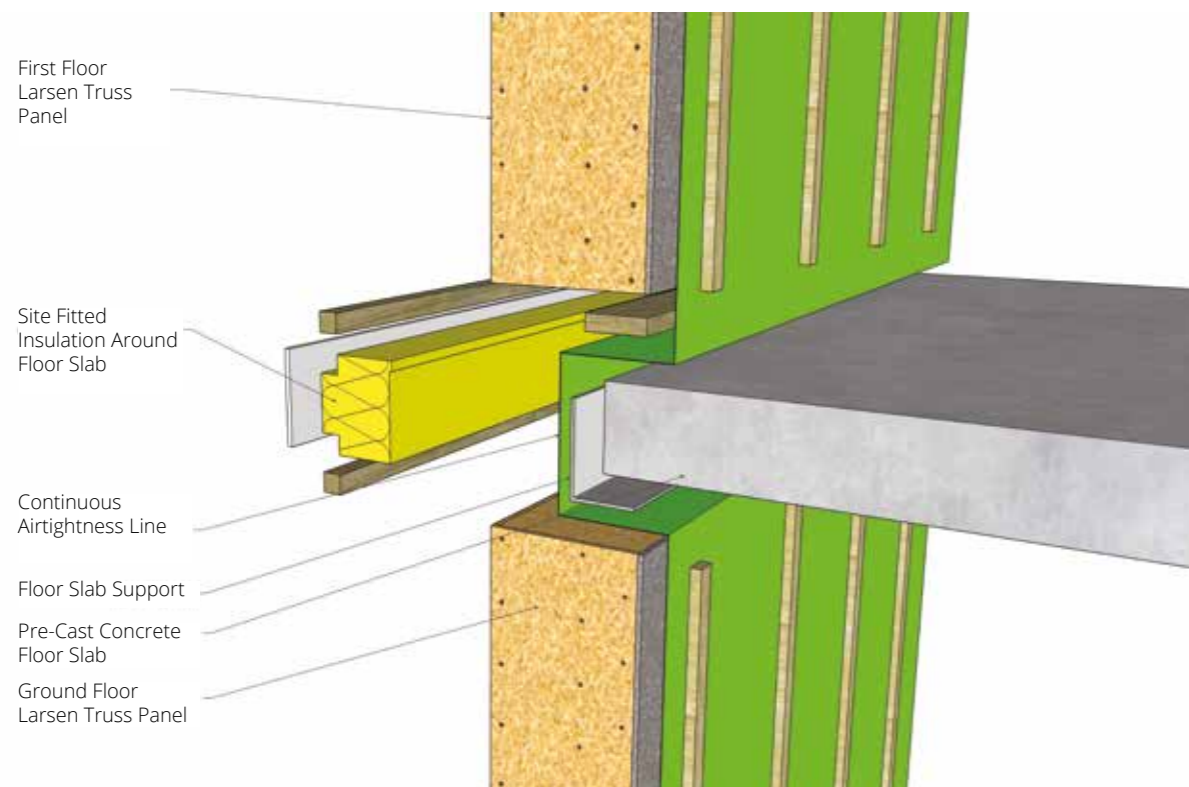

**Talk to our technical team to co-ordinate structural, acoustic and intermediate floor design requirements.**

## Roofs

We have extensive roof experience with a variety of structural solutions – for flat, pitched or even curved roof profiles. We can provide engineered trussed rafters, factory cassettes (insulated or structure only) and offer a full design, manufacture and installation service.

We can easily accommodate any roof-top plant/equipment loadings and can offer a choice of thermal and acoustic performance options. Integration with parapet and dormer solutions can be offered by our team as required.

### Roof Panels

We offer a range of engineered and insulated cassettes for flat and pitched roof solutions – these are bespoke to your project and the construction can be tailored to suit structural, thermal and airtightness requirements.

#### Cassette options:

- I Joist
- Metal Web Beam
- CLT
- Hollowcore concrete

### Roof Trusses

We have extensive experience across our group to design, manufacture and install trussed rafter solutions for pitched roofs.

### Parapets

Offsite parapet panels allow safe access onto flat roof areas and allow roof top plant to be discretely screened.

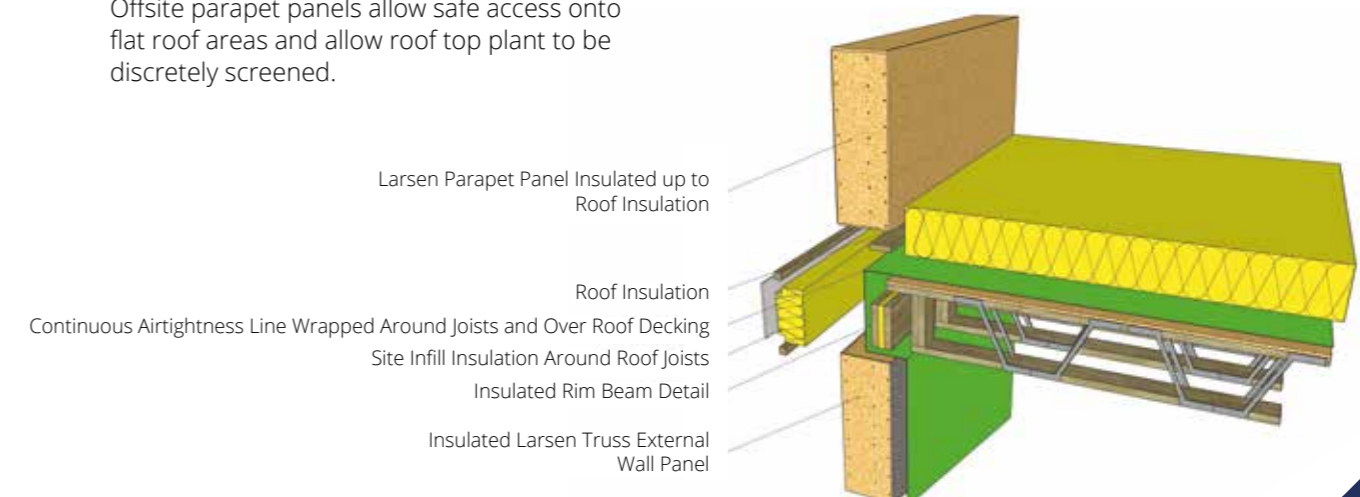

## Wrap – Infill Solutions

For steel or concrete primary frames, the Larsen system is still as effective in a 'Wrap Format'. In this application the panels form an insulated perimeter to the primary frame eliminating the cold bridge and providing a simple but effective solution to achieve the external wall line. The same principles can also be applied to floor and roof cassettes to integrate into the primary frame. Effectively we can manufacture a kit of parts to infill or wrap around a primary frame so the hybrid structure is complete.

- Closed panel thermal envelope solution
- Hybrid structures – Steel, Concrete or Glulam frame
- Deflection head detailing
- Unlimited choice of cladding



### Deflection Head Standard Detail

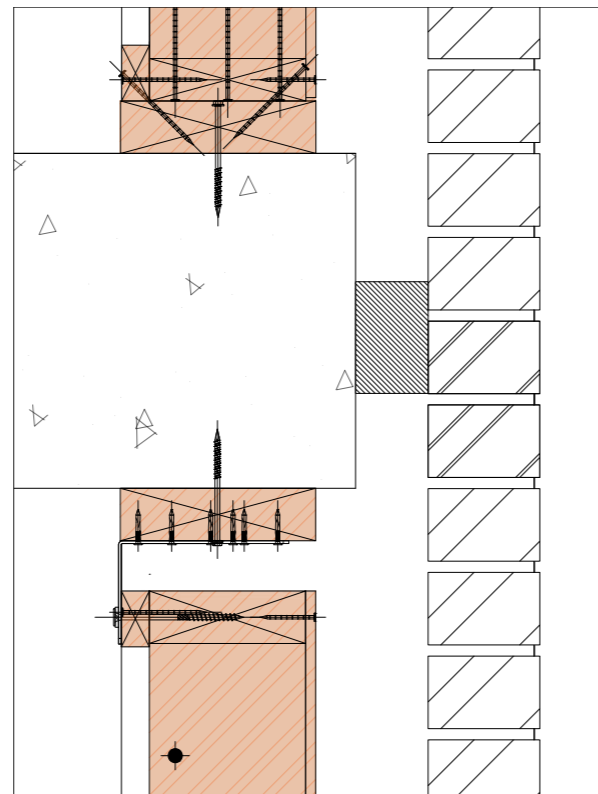

## Department For Education (DfE) – Framework Requirements

Our school superstructure solutions have been developed to address the stringent specifications required by the DfE for acoustics, fire, structure and durability. Our Larsen "Kit of Parts" approach to the DfE requirements ensure optimal Pre-Manufactured Value (PMV). We have experience of a range of education superstructures including Passivhaus compliance and feature glulam frame sports halls.

- Construction Framework 21 Compliant Solutions
- Enhanced Pre Manufactured Value (PMV)
- A1 Non-Combustible Insulants
- 100 minute tested fire performance
- Passiv schools experience



## BIM & Technical

Through our in-house engineering and design resources we closely control co-ordination and buildability from the start of technical input until buildings are installed and complete. For more complex builds our integration with other trades is fundamental to construction efficiency, so early stage understanding of MEP and ventilation/heating proposals steer the optimum structural outcome. Building Information Modelling (BIM) is the methodology best suited to understand and apply these disciplines at design stage before any manufacture commences and we integrate fully with the project team right from the start.

- The holistic process of creating and managing information for a built asset
- BS EN ISO 19650-1:2018 Compliant
- IFC file export to the design team
- Full technical support at every project stage

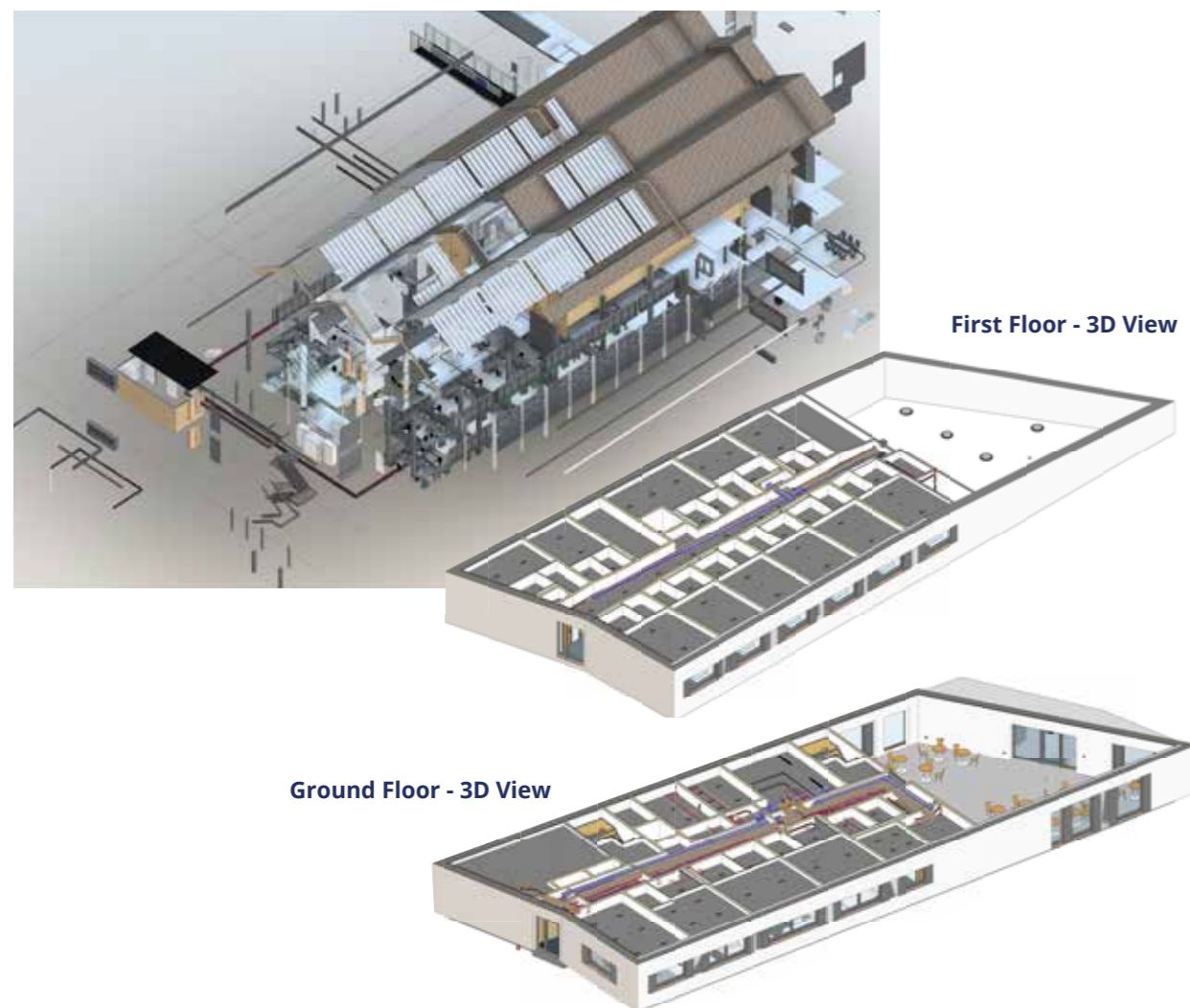

## Installation

With our proven performance from installation of major projects and innovative structures across the UK we understand your building requirements and can deliver the best level of performance and quality. We can provide a complete installation service for the superstructure to include all lifting and access requirements and full compliance with all necessary Health & Safety guidelines.

- All our installation teams are professional, trained and experienced
- Dedicated project manager and site supervision - SSSTS and SMSTS trained
- We provide all crane lifting within our package - 'in house' Appointed Person and slinger/signallers
- Scaffold/Access advice on requirements and Scaffoldless install options



For more information on any of our products visit [timberinnovations.co.uk](http://timberinnovations.co.uk)

# Sustainability

We have the only truly renewable raw material – Timber – at our heart and sustainability is embedded in everything we do. Our timber has full third party chain of custody to ensure it is responsibly sourced. Our product range is specifically focused on reducing the embodied energy in with its production whilst sequestering the carbon and reducing running costs plus associated emissions for the lifetime of the building. We have a plan to get to Net Zero right across our group of companies by 2030 and are well on the way with it. From investment in solar panels on our factories to new fleets of electric forklifts and cars

through to optimising deliveries across our manufacturing network to reduce transport miles – we really do 'practice what we preach'.

- All timber is PEFC or FSC certified and our group-wide purchasing carries full chain of custody from sapling to panel
- Passivhaus trained design and installation staff with extensive experience
- Carbon footprint analysis available for our production activity including sequestered carbon element
- Passiv schools experience



# Nationwide Coverage



Part of the Wyckham Blackwell  
Group of companies

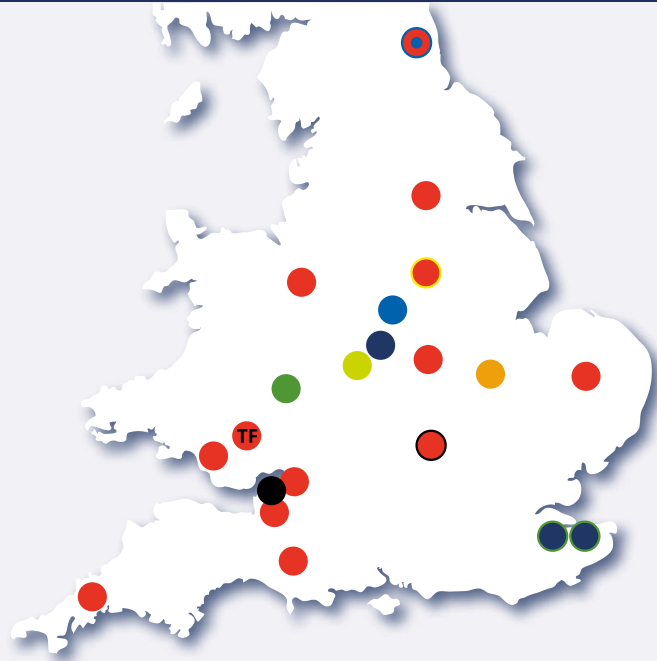

## Timber Innovations

Innovation House,  
Heming Road,  
Redditch, B98 0DH

**T:** 0121 314 7735

**E:** [info@timberinnovations.co.uk](mailto:info@timberinnovations.co.uk)

[timberinnovations.co.uk](http://timberinnovations.co.uk)

[timberframe.co.uk](http://timberframe.co.uk)

Registered Company Name: WB Timber Innovations Ltd